



# INSTALLATION INSTRUCTIONS INSTRUCCIONES DE MONTAJE



## Safety instructions / Instrucciones de seguridad

### Precautions / Precauciones:

It is important that you read, fully understand and observe the following safety instructions as well as the installation instructions. Careless or improper handling may cause injury or property damage.



*Es importante que lea, comprenda completamente y respete las siguientes instrucciones de seguridad, así como las instrucciones de montaje. El manejo descuidado o inadecuado puede causar lesiones o daños a la propiedad.*

Good footwear is very important. Wear sturdy boots with nonslip soles. Steel-toed safety boots are recommended.



*Un buen calzado es muy importante. Póngase botas gruesas con suela antideslizante. Recomendamos las botas de seguridad con puntera de acero.*

Knee-protection is recommended!



*¡Recomendamos la protección de rodilla!*

Always wear gloves when handling and installing the mats. Heavy-duty, nonslip gloves improve your grip and help to protect your hands.



*Siempre use guantes cuando maneje y monte los pisos de goma. Los guantes gruesos y antideslizantes mejoran el manejo y ayudan a proteger las manos.*

### During installation / durante el montaje:

Do not stand or work under suspended load (pallet)!



*¡No se pare ni trabaje bajo carga suspendida (palet)!*

- Do not underestimate the weight of the mats. Improper handling may cause injury.
- Only use the recommended tools.
- Observe the safety instructions of the tools' manufacturers.
- Caution when cutting: blade may move quickly through the rubber mat. Be sure you are cutting away from your body.
- Pallets can be broken! Watch out for splinters and / or nails!
- Take care to remove edge protectors or other small parts of packaging from cow feeding areas!



- *No subestime el peso de los pisos de goma. El manejo inadecuado puede causar lesiones.*
- *Solo use las herramientas recomendadas.*
- *Respete las instrucciones de seguridad de los fabricantes de herramientas.*
- *Tenga cuidado al cortar: la cuchilla puede moverse rápidamente a través del piso de goma. Asegúrese de estar cortando lejos de su cuerpo.*
- *¡Los palets se pueden romper! ¡Cuidado con las astillas y / o los clavos!*
- *¡Tenga cuidado de quitar los protectores de bordes u otras partes pequeñas de los envases de las áreas de alimentación de las vacas!*

### After installing / después del montaje:



Caution!  
Cows will be more active!

*¡Cuidado!  
¡Las vacas podrían ser más activas!*



Watch out for uneven edges if the floor is only partially covered.

*Tenga cuidado con los desniveles en los bordes si el piso está cubierto solo parcialmente.*



Residues on the rubber may cause slippery condition while and shortly after installing!

*¡Los residuos sobre la goma pueden causar condiciones resbalosas durante y poco después del montaje!*

# KRAIBURG CALMA

## Requirements:



### concrete areas:

- smooth
- clean
- minimum 3% slope

### mats:

Installation Temperature:  
minimum 41°F (5°C) to maximum 86°F (30°C) (be sure internal temperature of mats falls within above range)

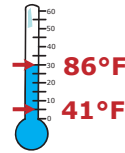

for animal hygiene some bedding is necessary to absorb moisture

## You will need this:

### measuring:

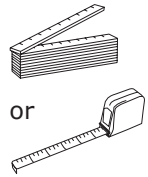

### marking:

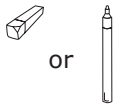

### cutting:

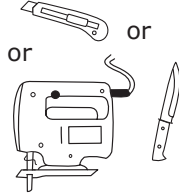

### drilling and installing:

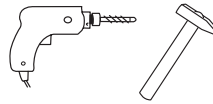

### fastening components:

- 1/4" x 3" steel anchor
- 1-1/8" SS curved washer

(or fastening components with at least the same resistance and durability)

## 1 Lay out mat row completely

**tip:** first make a mark 1" (3 cm) from the rear curb along entire length of row (a chalk line works well for this)

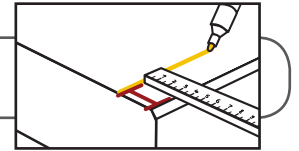

Position mats to be fastened across front of stall

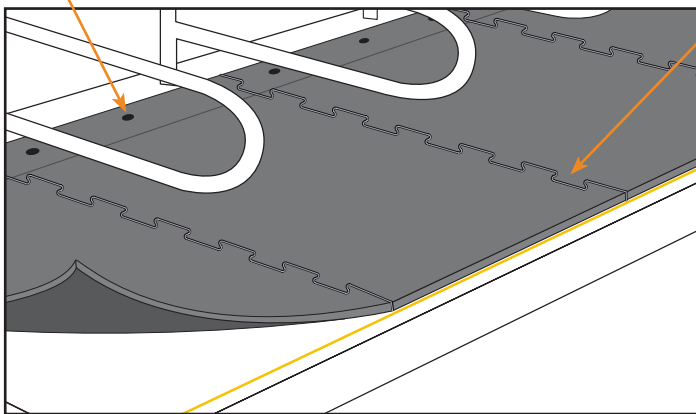

Recommended: Puzzle seam falls below stall dividers

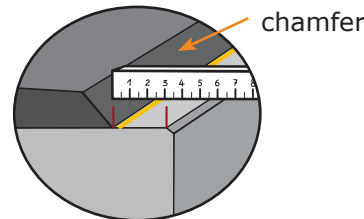

Distance from mat to edge of curb: minimum 1" (3 cm)

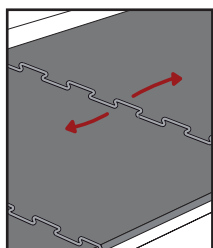

join mats loosely, lift them slightly and gently pull them apart



**avoid creating tension!**

DO NOT PRESS!

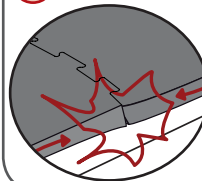

DO NOT PULL ON ONE END ONLY!

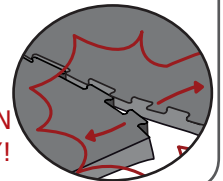

### Mushroom divider:

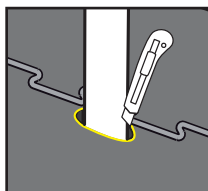

cut mats to fit

Appropriate installation may differ due to local conditions. Therefore the manufacturer is not liable for installation!



## ② Fastening

evenly space three anchors across front of mat

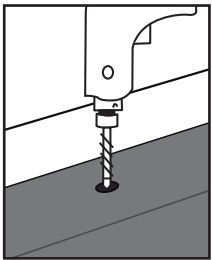
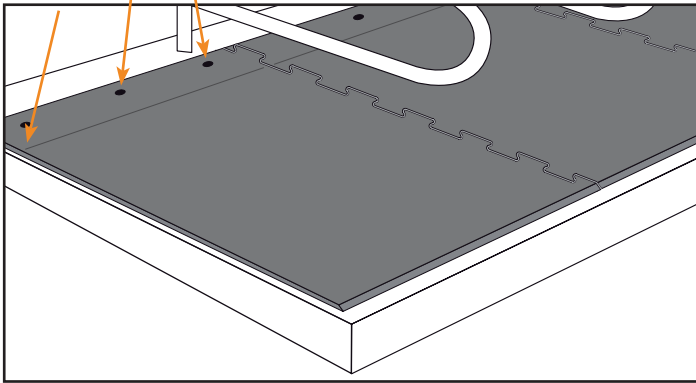

drill

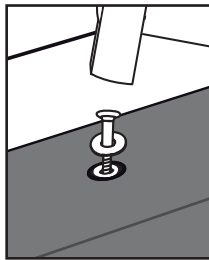

pound in anchors and washers until they are seated firmly and are slightly countersunk

### ***When using in a cubicle for fattening bulls:***

add two additional anchors and washers along back edge of mat:

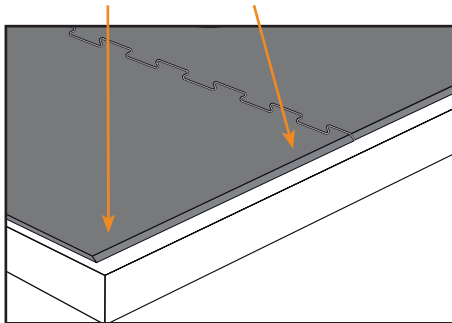

distance from  
side edge:  
about 3"  
(about 8 cm)

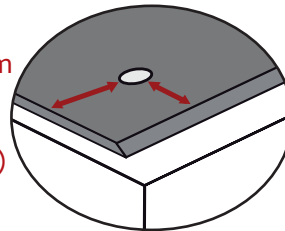

distance from rear edge:  
about 2" (about 5 cm)

